



Cover 2:
Destiny Silver

Cover 3:
Crinkle Silver

Cover 1:
Kora Silver

Chrome Feet

Dazzle Collection

Colours represented are to be used as a guide only.
Please refer to manufacturers swatch for a more accurate colour match.

Please note that colour shadings can vary slightly from each roll of fabric.
We cannot guarantee a precise match to these samples or between cut lengths and upholstered goods.

18/02/2020

DAZZLE COVER GUIDE - STANDARD BACK

Please use this guide when ordering the following pieces to clarify cover options.

STANDARD BACK

Chaise Sofa L2, R2V, VP / R2, L2V, VP
(LH2, R2V, VP / RH2, L2V, VP)

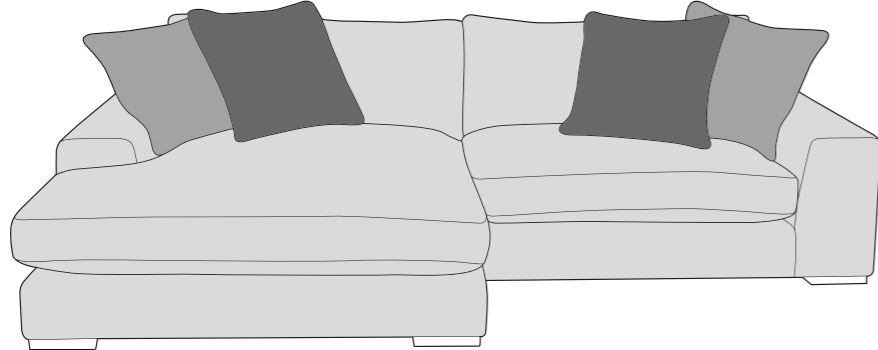

3 Seater Sofa (3ST)

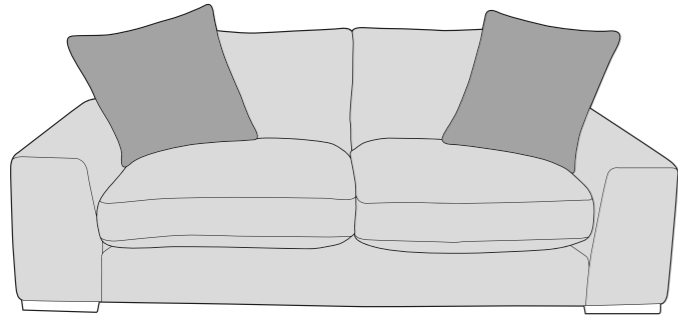

Arm Chair (1ST)

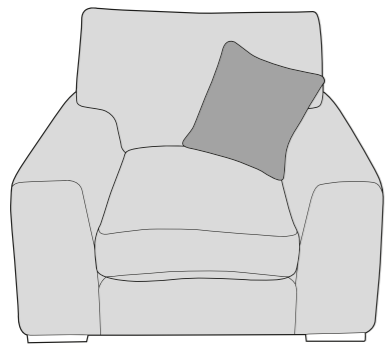

2 Seater Sofa (2ST)

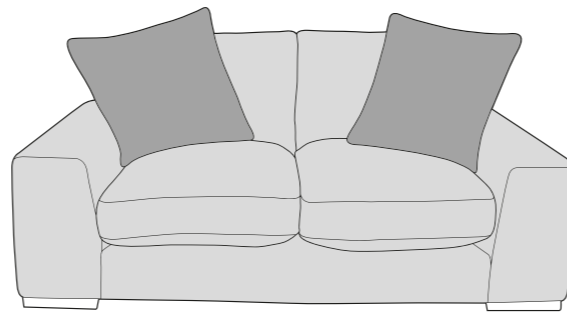

Dazzle (Paris)
Swivel Chair (SWC)

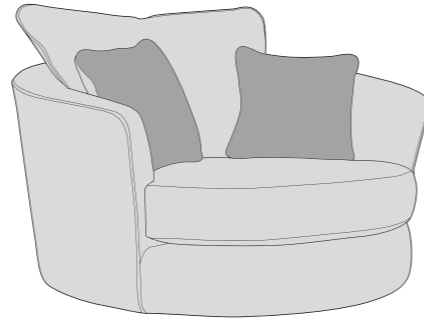

4 Seater Sofa (4ST)

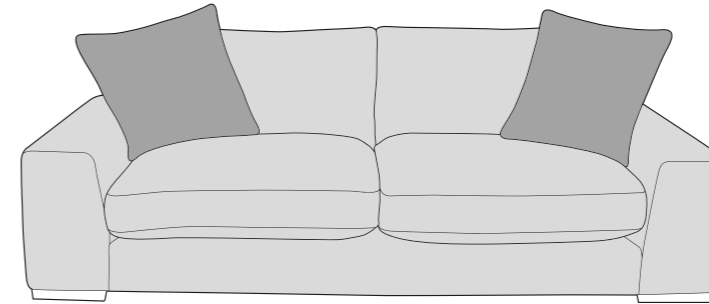

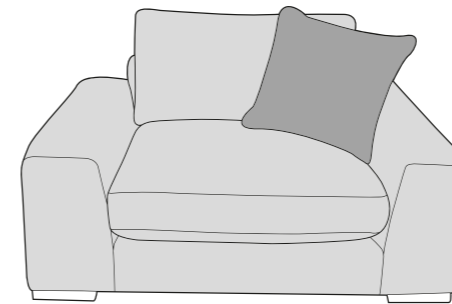

Love Chair (LOV)

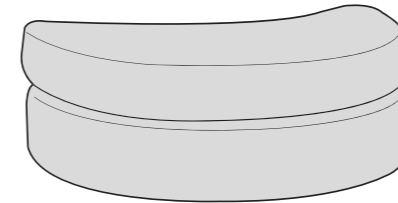

Dazzle (Cuddler)
Footstool (FST)



-  **COVER 1**
(BODY)
-  **COVER 2**
(SCATTER)
-  **COVER 3**
(SCATTER)

Standard Back Scatter Cushions

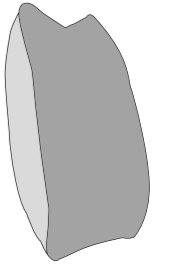

Front = Cover 2
Back = Cover 1

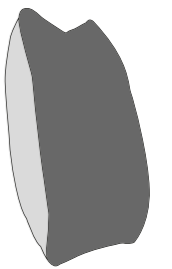

Front = Cover 3
Back = Cover 1

ACCENT PIECES

Storage Footstool (FSS)

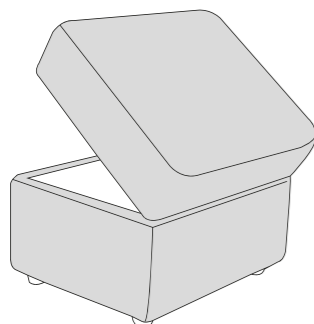

Large Footstool (FST)

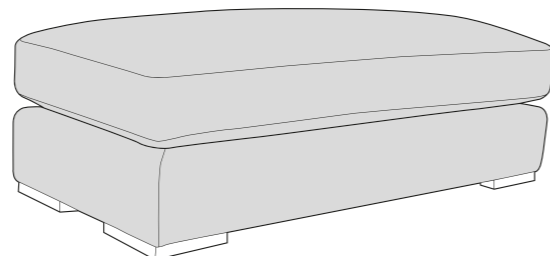

DAZZLE DIMENSIONS (CM)

AVAILABLE PIECES	HEIGHT 1	WIDTH 2	DEPTH 3	SEAT HEIGHT 4	SEAT DEPTH (STD) 5	SEAT DEPTH (PILLOW) 5	SEAT WIDTH 6	ACCESS DIAGONAL 7	WEIGHT (KG)	PILLOW BACK NO.	SCATTER CUSHION NO.
CHAISE SOFA	90	280	166	49	128	N/A	226	175, 216	121.5	N/A	4
4 SEATER SOFA	90	274	107	49	65	N/A	189	264	81	N/A	2
3 SEATER SOFA	90	218	107	49	65	N/A	158	238	77	N/A	2
2 SEATER SOFA	90	195	107	49	65	N/A	139	215	70	N/A	2
LOVE CHAIR	90	153	107	49	65	N/A	97	184	69	N/A	1
ARM CHAIR	90	108	107	49	65	N/A	60	149	47.5	N/A	1
ACCENT PIECES											
STORAGE FOOTSTOOL	43	63	50	N/A	N/A	N/A	N/A	75	13	N/A	N/A
LARGE FOOTSTOOL	49	140	62	N/A	N/A	N/A	N/A	150	22	N/A	N/A

- * Hardwood & composite board frame.
- * Dowelled, screwed, glued & stapled joinery.
- * Chrome foot options.

- * Available with standard back option.
- * Feather filled scatter cushions included.



- * Fibre filled high comfort reversible seat cushions.
- * Reversible fibre filled backs for added comfort.

DIMENSION GUIDE

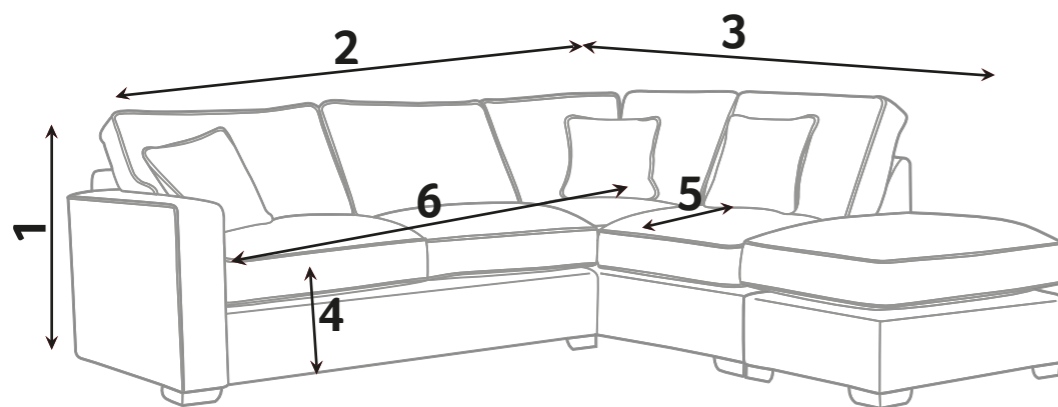

Check the diagonal access dimension to ensure furniture will fit in your home.

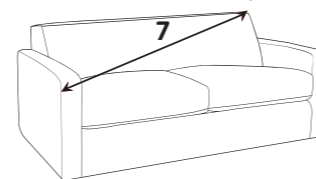

- 1 - HEIGHT
- 2 - WIDTH
- 3 - DEPTH
- 4 - SEAT HEIGHT
- 5 - SEAT DEPTH (STD & PILLOW)
- 6 - SEAT WIDTH
- 7 - DIAGONAL ACCESS

Illustrations used for reference only.

FIBRE FILLED SEATS

Fibre filled seat interior with a hand-rolled carded fibre that provides both comfort and a relaxed feel.

Excluding foam filled Large Swivel Chair, D Footstool & Storage Footstool.

CARE GUIDE

Fibre filled seat cushions should be plumped up on a regular basis to help maintain the aesthetic appeal of your upholstery, the plumping of cushions is essential to help retain the comfort and softness of any piece of upholstered furniture.

To improve the longevity of your hand-made furniture, we recommend rotating cushions (where applicable).

For further information on maintaining your furniture please refer to the care guide located under the seat platform.

Chrome

FOOT OPTIONS:



Feet may require fitting.

Please note : All dimensions are approximate. Allow tolerance of +/- 2.5cm.



The mark of responsible forestry